

# ELETTROBAR

**SPARE PARTS CATALOGUE  
ERSATZTEILKATALOG  
CATALOGUE PIECES DETACHEES  
CATALOGO PARTI RICAMBIO  
CATALOGO DE PIEZAS DE RECAMBIO  
CATALOGO PEÇAS DE REPOSIÇÃO**

# Niagara 35

**02-11-2005**

# 1

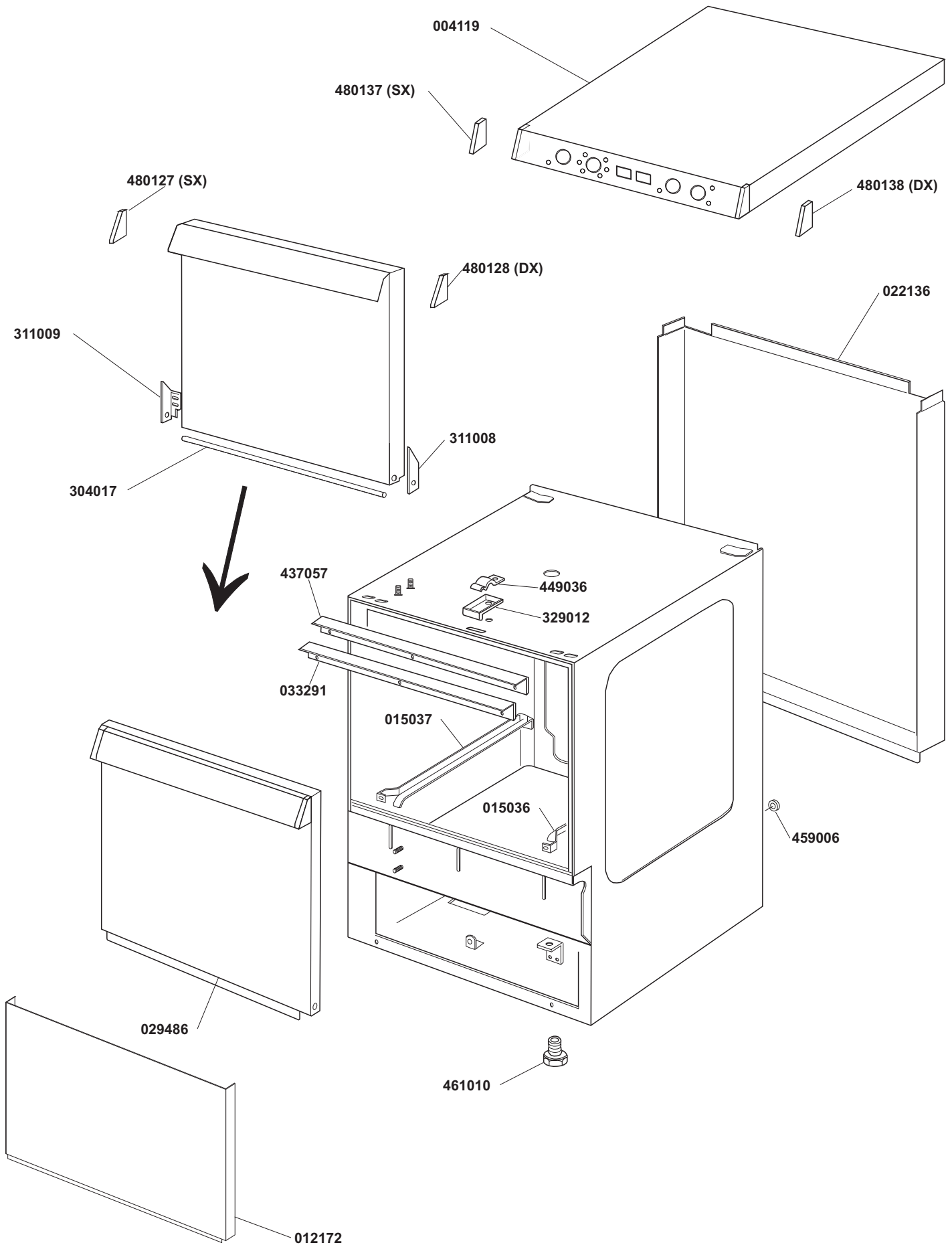

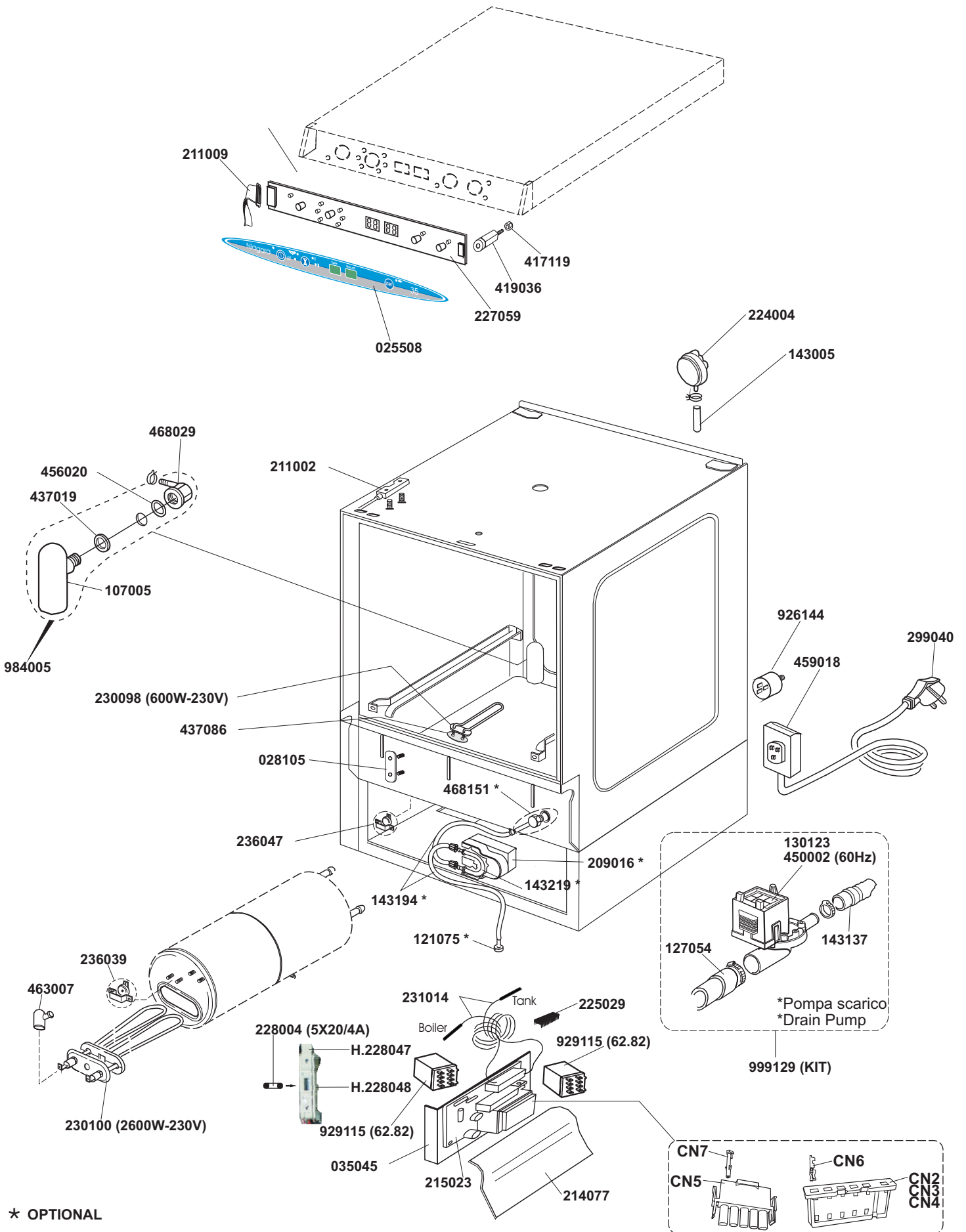

\* OPTIONAL



# 4

